

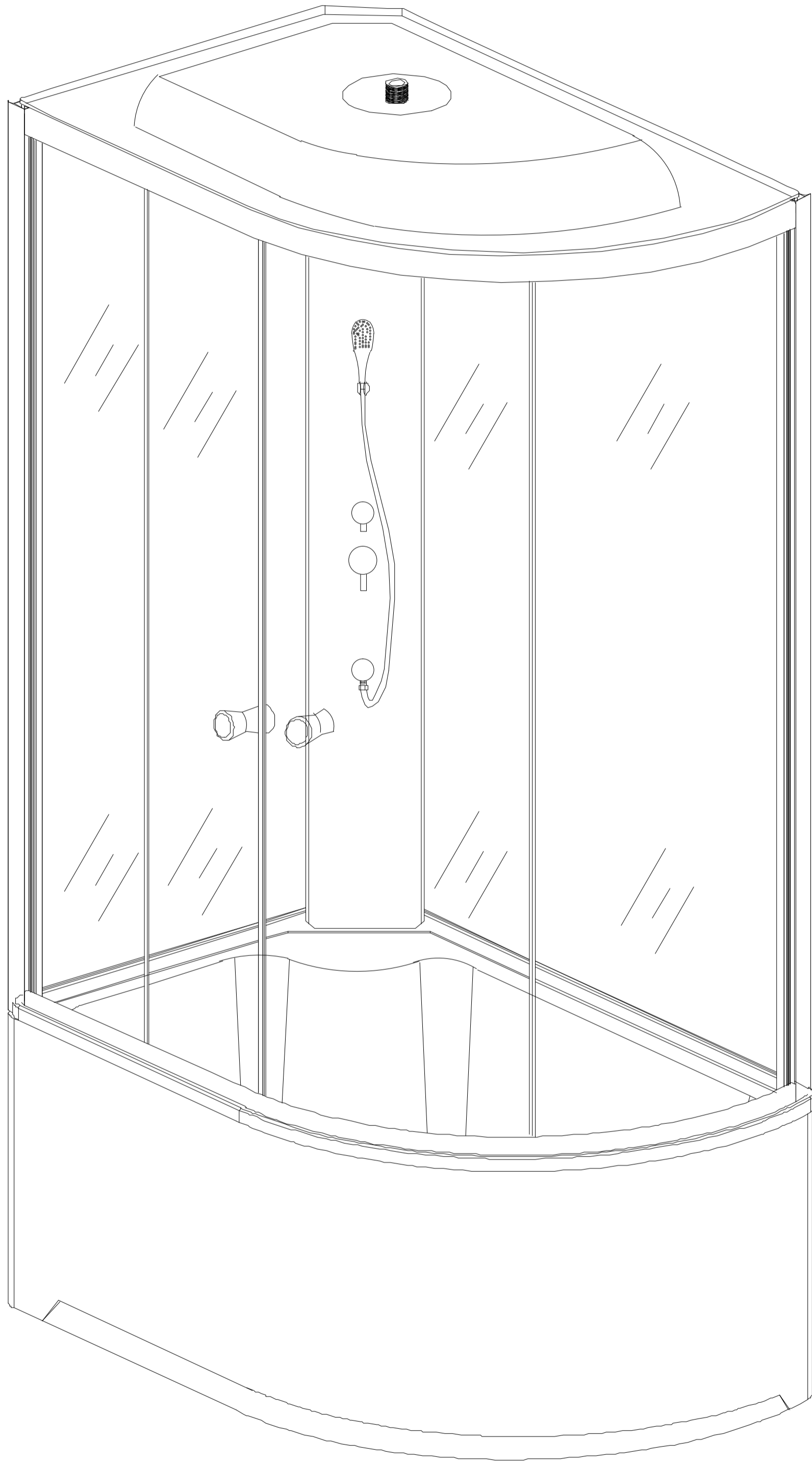

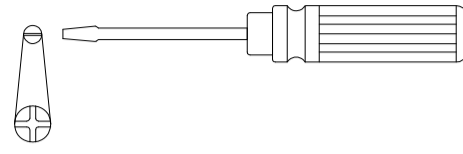

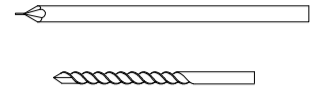

L920L/R

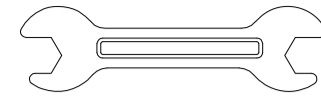
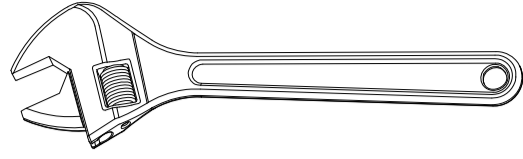
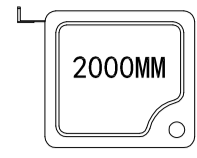
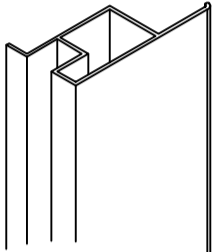
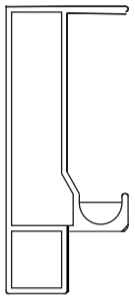
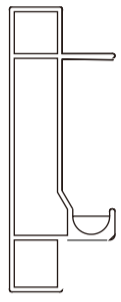
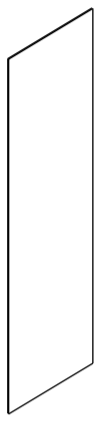
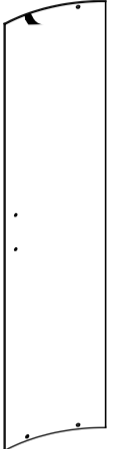
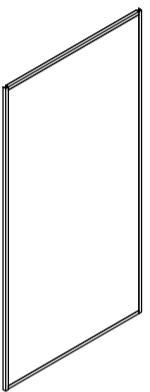
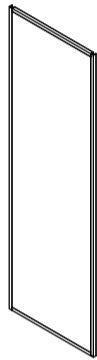
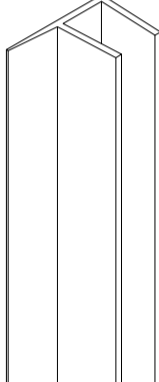
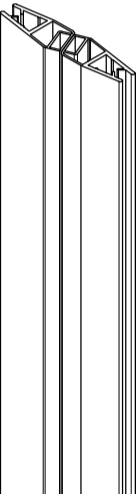
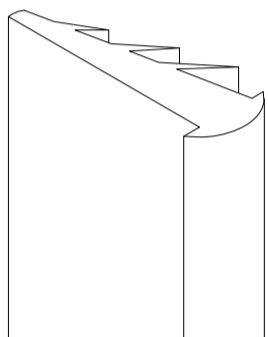
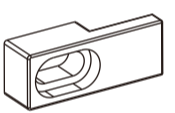
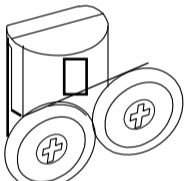
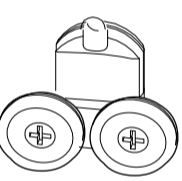
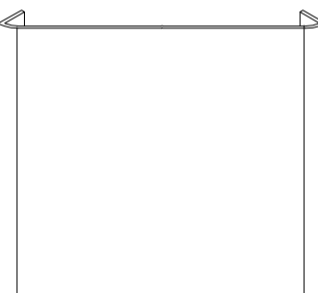
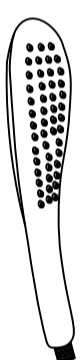
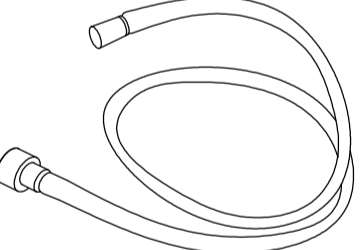
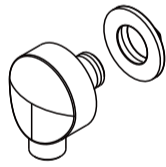

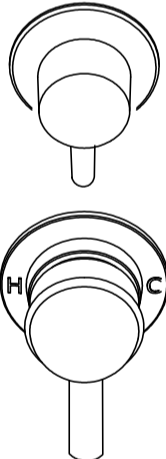
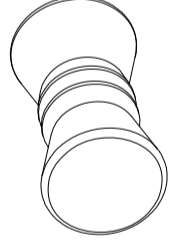
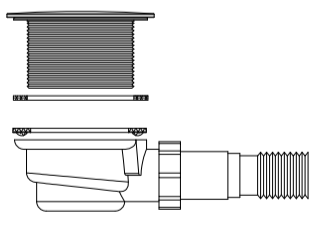
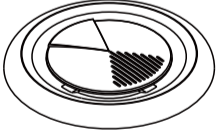
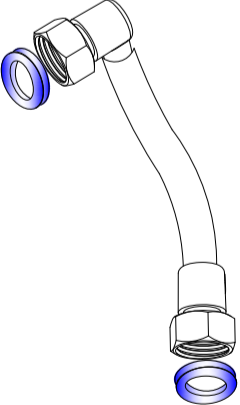
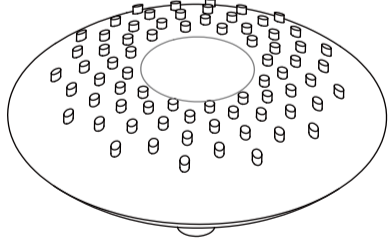

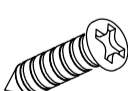
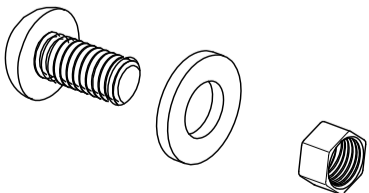
<p>A1</p>  <p>X2</p>	<p>A2</p>  <p>X1</p>	<p>A3</p>  <p>X1</p>	<p>A4</p>  <p>X2</p>	<p>A5</p>  <p>X2</p>
<p>A6</p>  <p>X1</p>	<p>A7</p>  <p>X1</p>	<p>A8</p>  <p>X4</p>	<p>A9</p>  <p>X1</p>	<p>A10</p>  <p>X2</p>
<p>A11</p>  <p>X4</p>	<p>A12</p>  <p>X4</p>	<p>A13</p>  <p>X4</p>	<p>A14</p>  <p>X1</p>	<p>A15</p>  <p>X1</p>
<p>A16</p>  <p>X1</p>	<p>A17</p>  <p>X1</p>	<p>A18</p>  <p>X1</p>	<p>A19</p>  <p>X1</p>	<p>A20</p>  <p>X2</p>
<p>A21</p>  <p>X1</p>	<p>A22</p>  <p>X2</p>	<p>A23</p>  <p>X2</p>	<p>A24</p>  <p>X1</p>	<p>A25</p>  <p>X4</p>
<p>ST4X12=4</p>  <p>M4X25=2</p> 	<p>ST4X50=8</p> <p>ST4X12=8</p> <p>ST4X10=32</p> 			

L1=440MM=4
L2=180MM=1
L3=130MM=1

ST4X35=6

M12=14

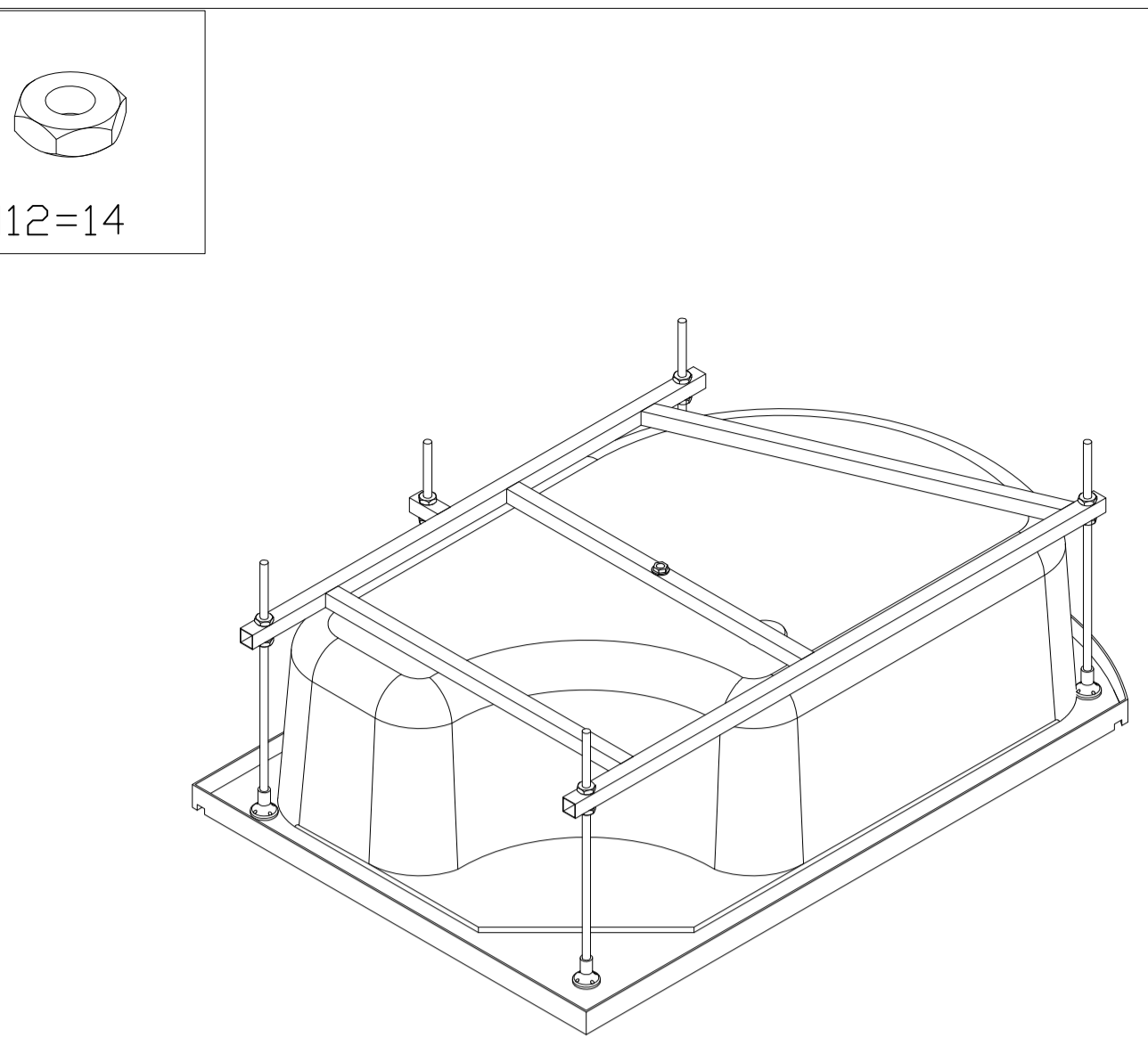
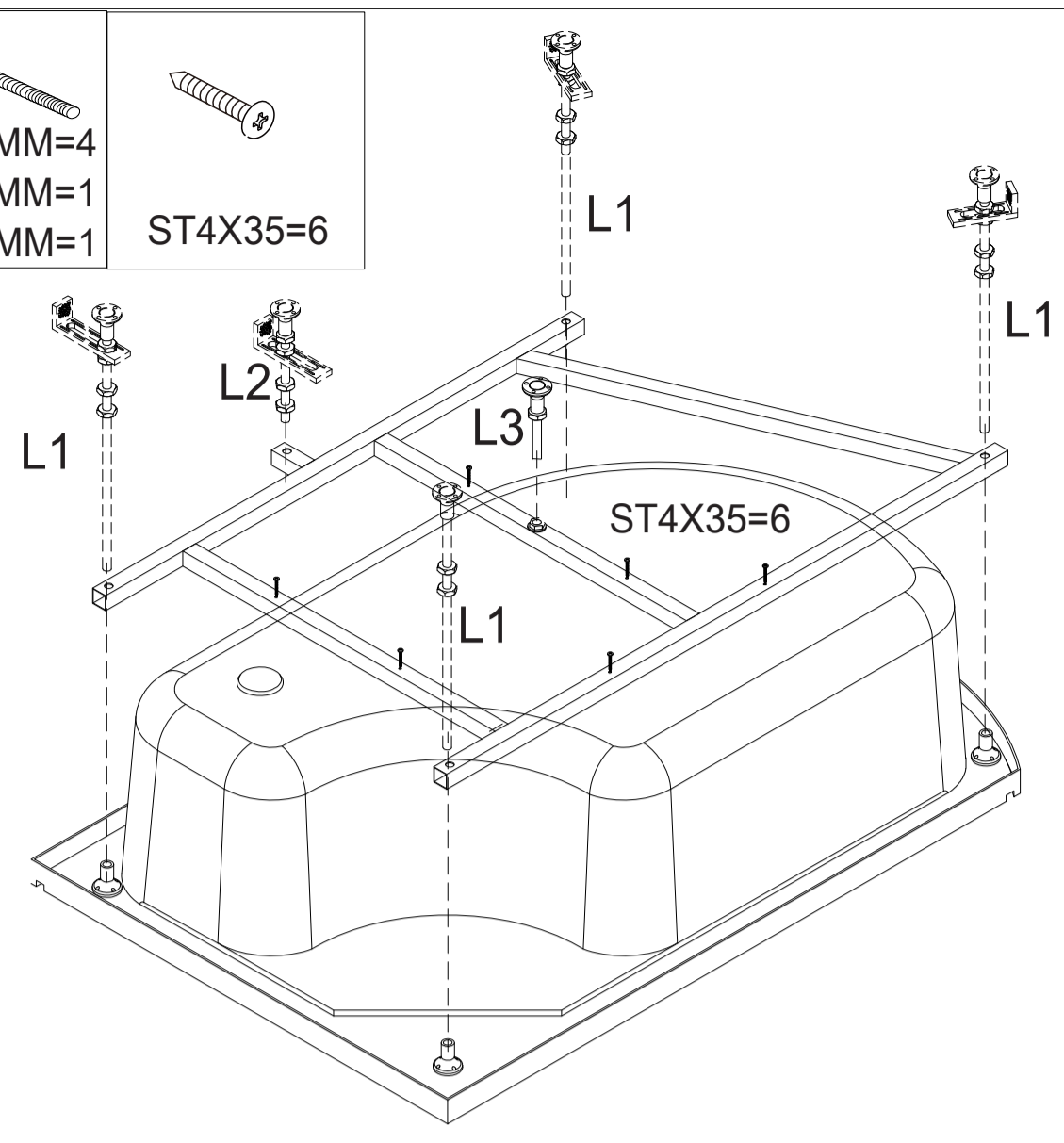

M12=15
M12=8
X6
X4

X5

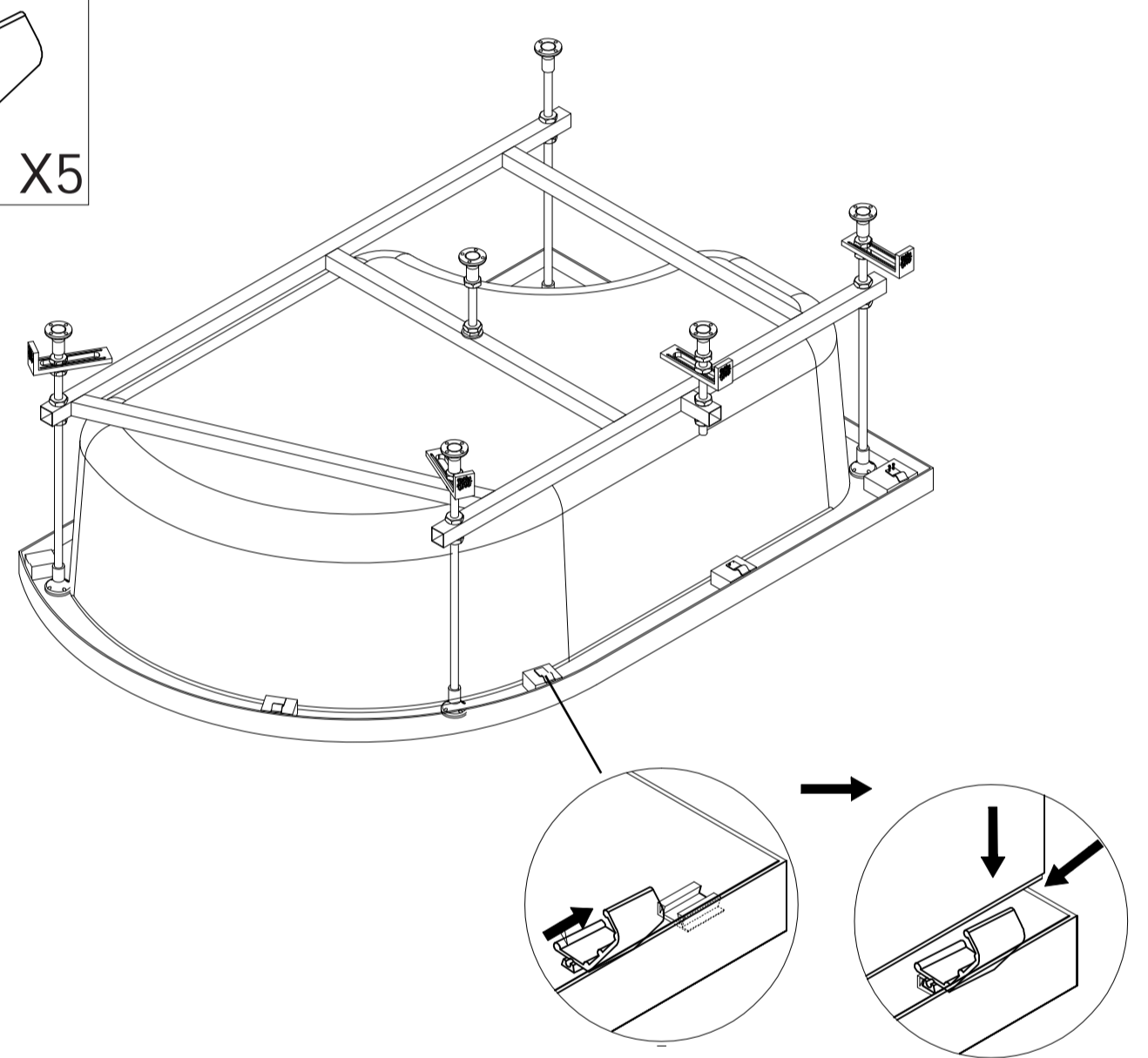
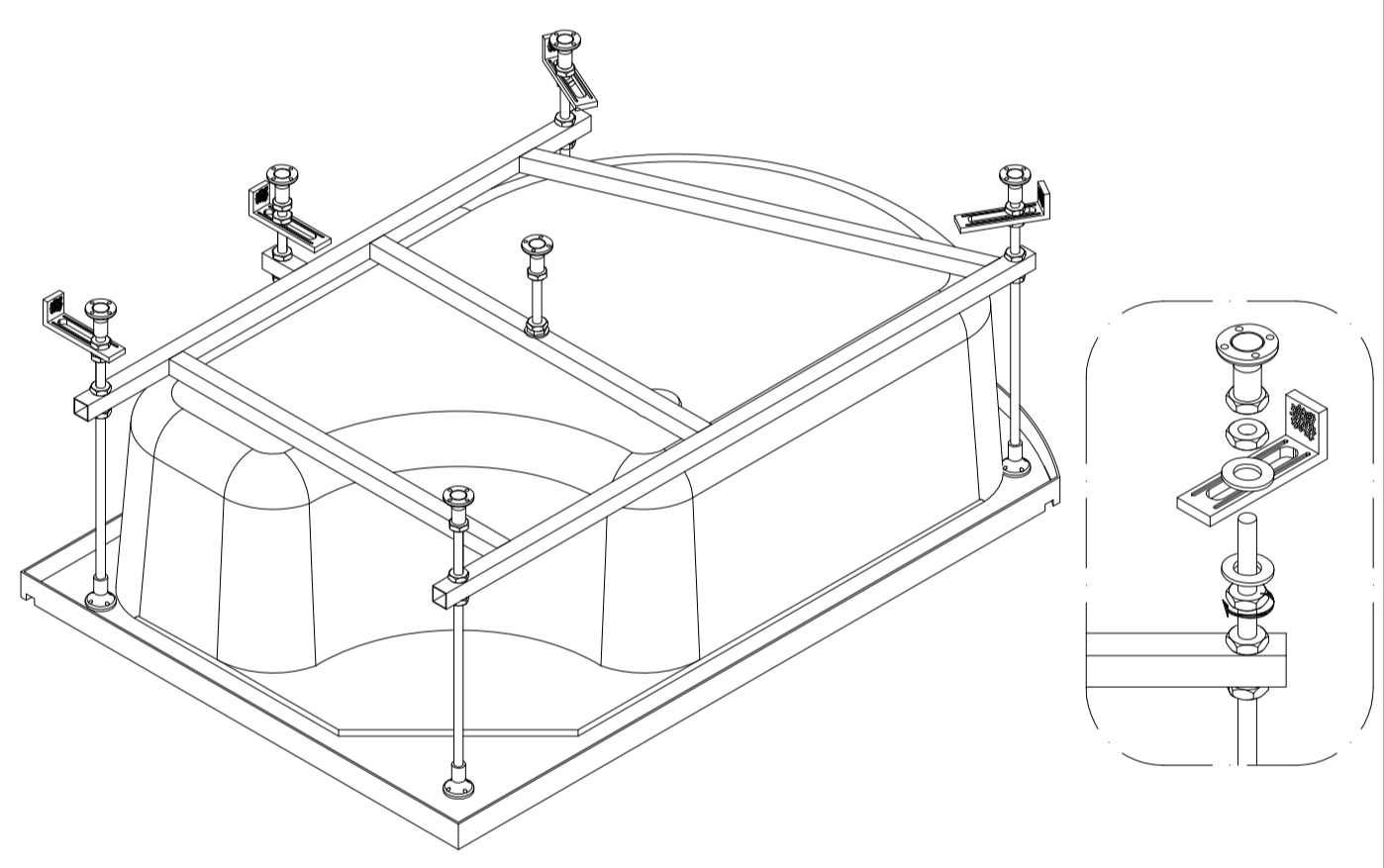

ST4X16=4

A21

